

# スライドL型プレート

## 銅合金タイプ

### SLIDE L-SHAPE PLATE

SOL

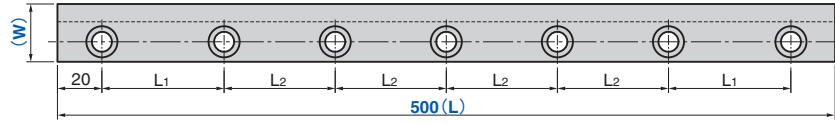
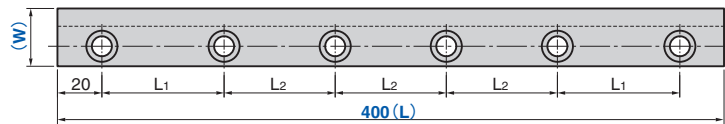
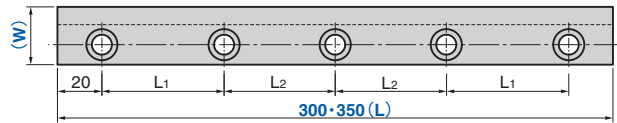
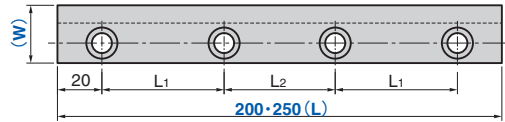
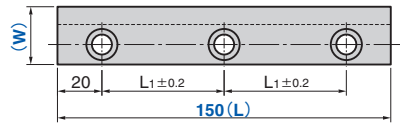
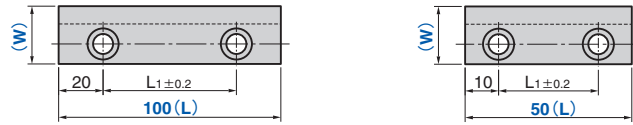
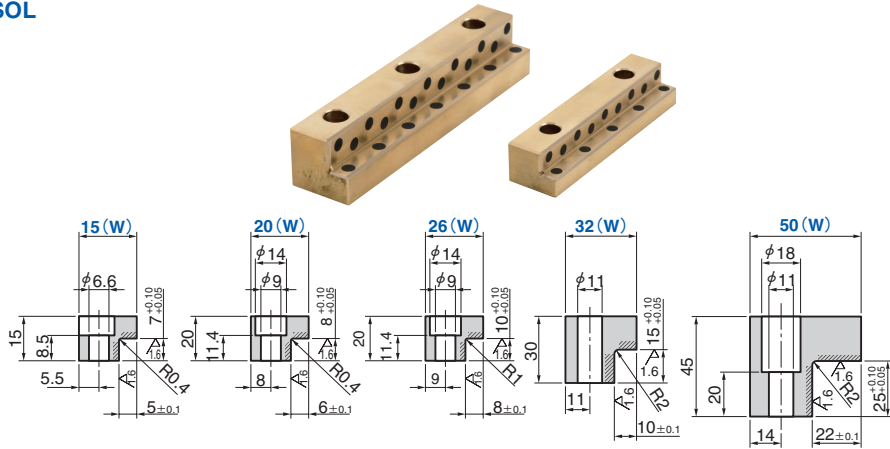

●スライド方向



(材質) SO#50SP2  
////部オイルレス加工

Catalog No.	W	L	ボルト取付位置		取付ボルト	
			L <sub>1</sub>	L <sub>2</sub>	サイズ	個数
15	15	50	30		M6	2
		100	60	—		
		150	55	50		
20	20	50	30		M8	2
		100	60	—		
		150	55	50		
26	26	100	60		M8	2
		150	55	—		
		200	55	50		
SOL	32	100	60		M8	2
		150	55	—		
		200	55	50		
32	32	200	75	70	M10	4
		400	60	—		
		100	55	50		
50	50	200	70	70	M10	6
		250	55	50		
		300	65	65		
50	50	350	80	75	M10	5
		500	80	75		

Order **SOL** **50** - **200**

●W=15 取付穴形状

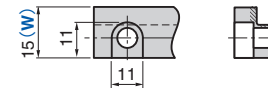

●W=32 取付穴形状

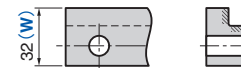

スライド関連部品